

7

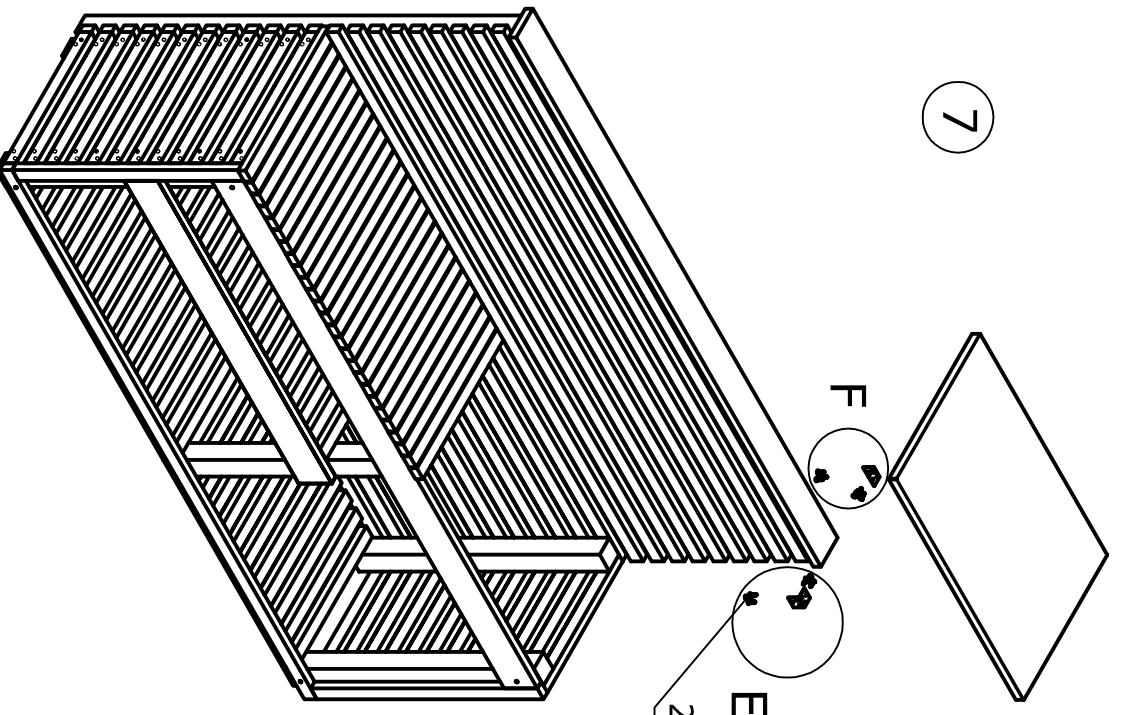

24 pcs Screws $\phi 3 \times 20$ mm

F (1 : 2)

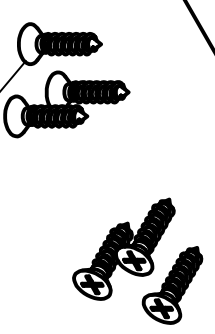
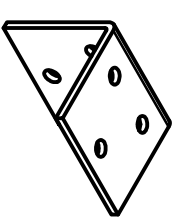

Screws $\phi 3 \times 20$ mm

E (1 : 2)

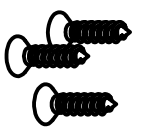
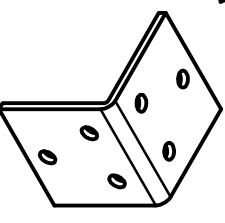

8

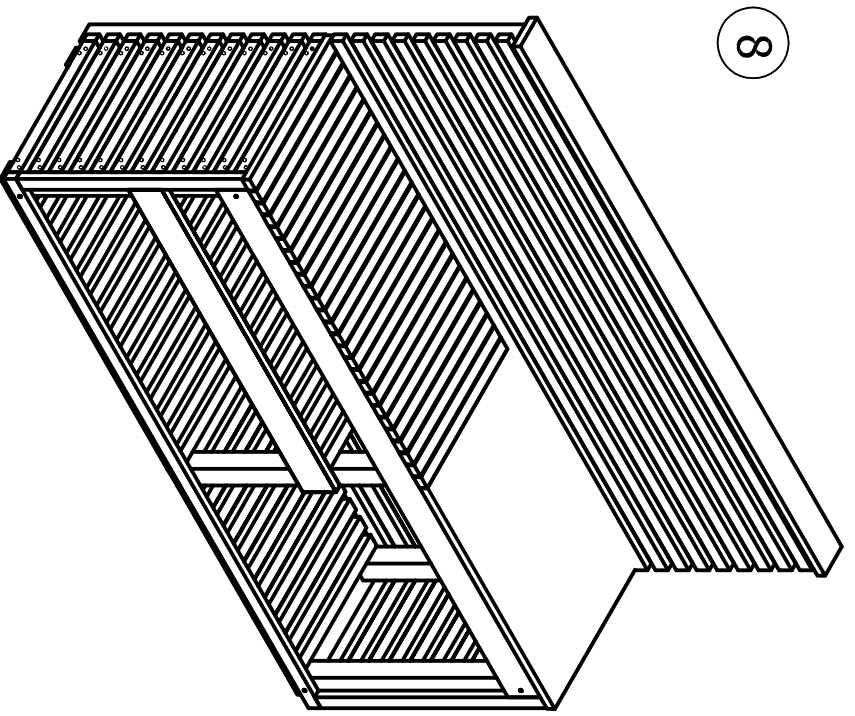

L (1 : 2)

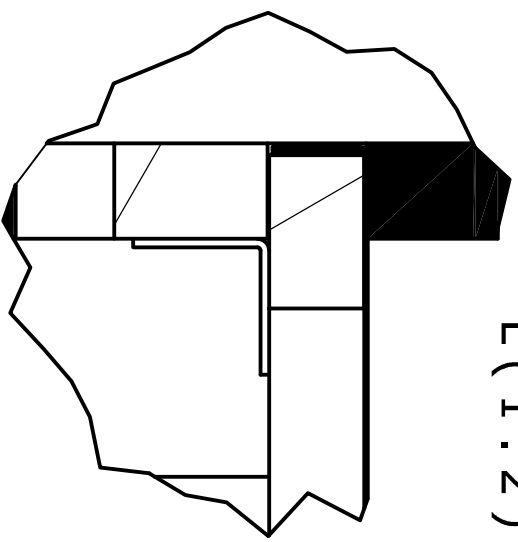

K (1 : 2)

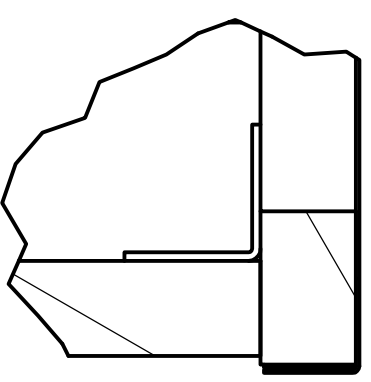

J-J (1 : 20)

